



# ORTHOPEDIC INSTRUMENTS

# CATALOGUE

✉ [info@simzmedicalsupplies.com](mailto:info@simzmedicalsupplies.com)

🌐 [www.simzmedicalsupplies.com](http://www.simzmedicalsupplies.com)

## About Our Company



SIMZ medical supplies Co. is a trading company that is committed to delivering quality medical supplies. SIMZ prides itself in delivering single use and reusable Dental, Surgical and Orthopedic instruments. Our products are manufactured by using the highest quality stainless steel (AISI, ASTM and DIN standards, which is imported from Germany, Japan & France). We are committed to producing and serving the best quality instruments. We are devoted to delivering quality products at affordable prices.

### 1 Dental Instruments

Dental instruments are tools that dental professionals use to provide dental treatment. They include tools to examine, manipulate, treat, restore and remove teeth and surrounding oral structures

### 2 Surgical Instruments

A surgical instrument is a tool or device performing specific actions or carrying out desired effects during a surgery or operation, such as modifying biological tissue, or to provide access for viewing it

### 3 Orthopedic Instruments

Orthopedic surgery instruments are designed for surgeries related to muscles, joint, ligaments and bones. Our extensive range of orthopedic instruments accommodates a variety of medical approaches

**SIMZ-001 ESMARCH Plaster Shears**

• 8" (20.3cm)



**SIMZ-002 BRUNS Plaster Shears**

• 9½" (24.1cm)

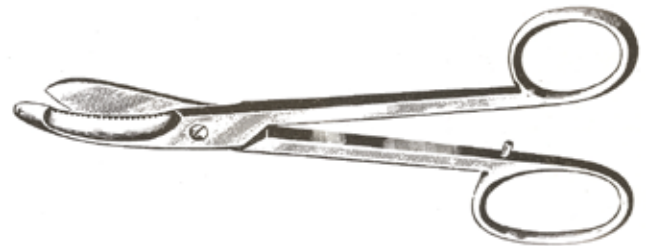

**SIMZ-003 Plaster Shears**

• 7½" (19.1cm) eccentric lock



**SIMZ-004 Plaster & Utility Shears**

• 8" (20.3cm) notched blade



**SIMZ-005 Utility Shears**

• 5½" (14cm), one serrated blade  
stainless steel with autoclavable plastic finger rings



**SIMZ-006 Utility Shears**

• 7" (17.18cm), one serrated blade,  
stainless steel with autoclavable plastic finger rings



**SIMZ-007 STILLE Plaster Shears**

• 15" (38.1cm)



**SIMZ-008 WOLF-BOEHLER Cast Breaker**

• 9¾" (24.8cm)



**SIMZ-009 HENNING Cast Spreader**

• 10¾" (27.3cm)



**SIMZ-010 3 Prong Cast Spreader**

• 9" (22.8cm)

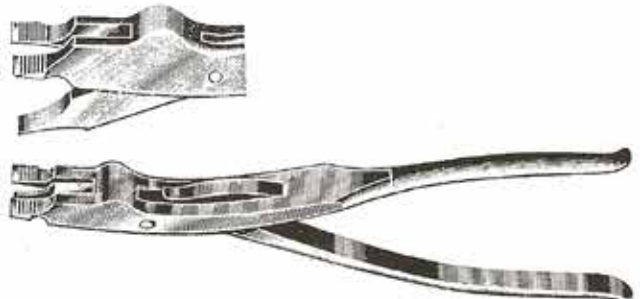



**SIMZ-011 KERN Bone Holding Clapms Ratchet**

- 5 ½" (14cm)

**SIMZ-012**

- 8 ½" (21.6cm)

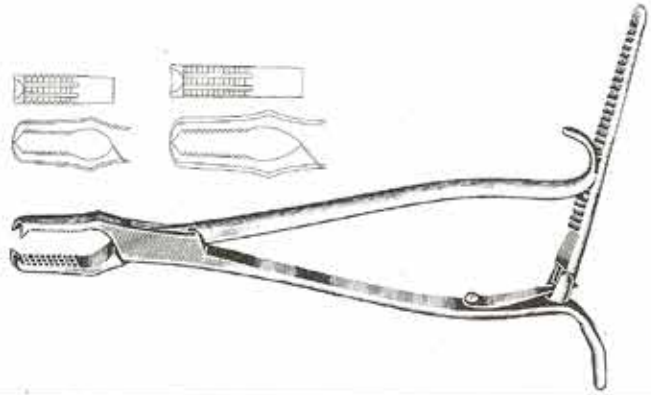

**SIMZ-013 LANE Bone Holding Clapms Ratchet**

- 13" (33cm)

**SIMZ-014**

- 13" (33cm) Heavy

**SIMZ-015**

- 17" (43.2cm)

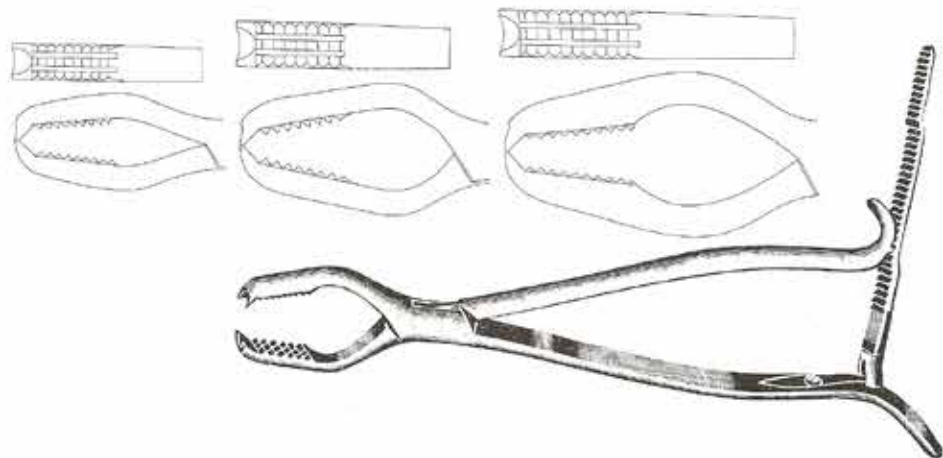

**SIMZ-016 Bone Reduction Forceps, Speed lock, Curved Jaws**

- 7" (17.8cm)

**SIMZ-017**

- 9" (22.8cm)

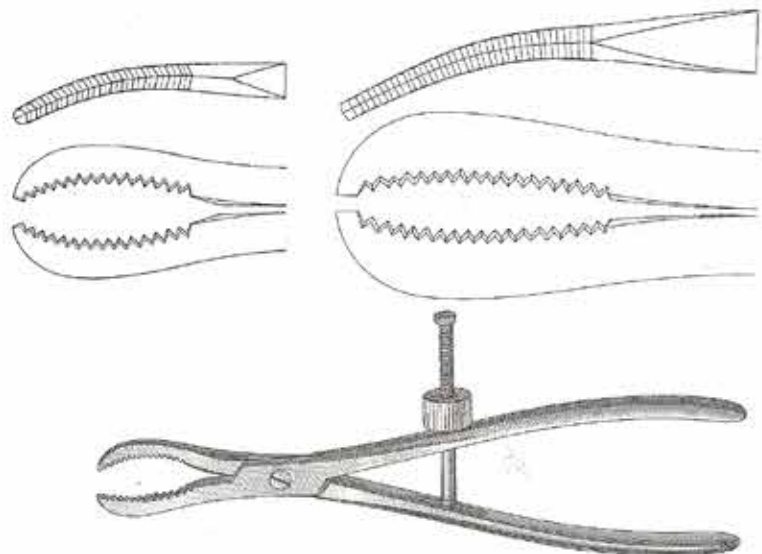

**SIMZ-018 Bone Reduction Forceps,**

- 5 ½" (14cm) curved jaws

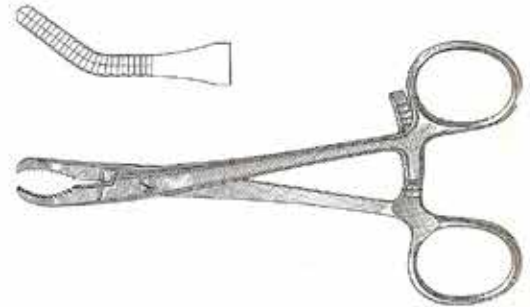

**SIMZ-019 Bone Reduction Forceps,**

- 8" (20.3cm) 2" (5.1cm) long ratchet  
jaw opening from ¾" to 4" (0.9cm x 10.1cm)

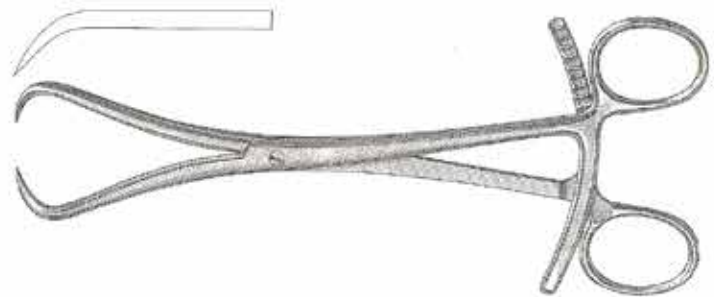

**SIMZ-020 Bone Reduction Forceps,**

- 6" (15.2cm), curved

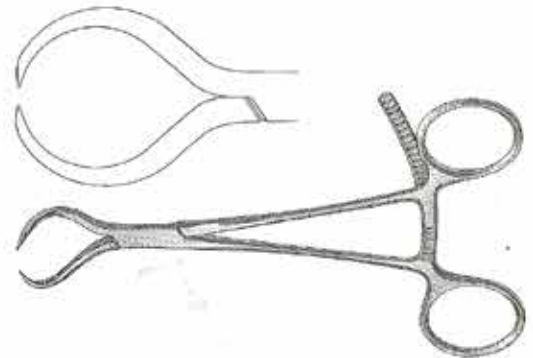

**SIMZ-021 LAMBOTTE Bone Holding Clamp,**

• 12" (30.5cm)

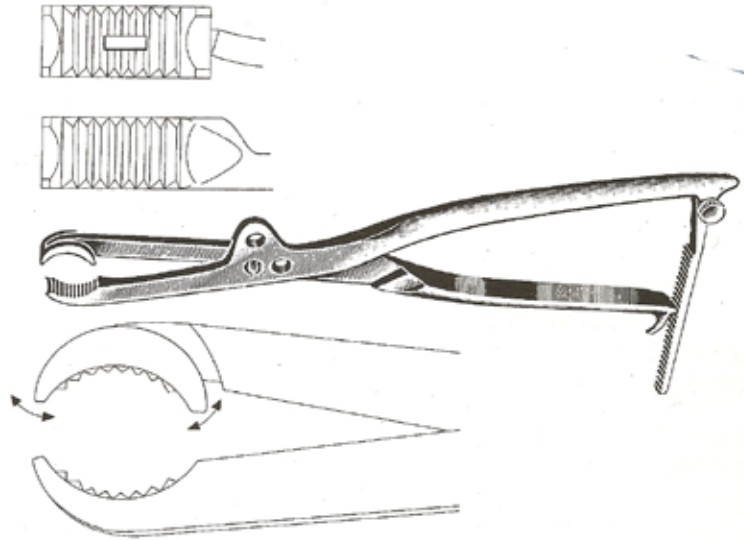

**SIMZ-022 FARABEUF-LAMBOTTE Bone Holding Clamp,**

• 10 1/2" (26.7cm)

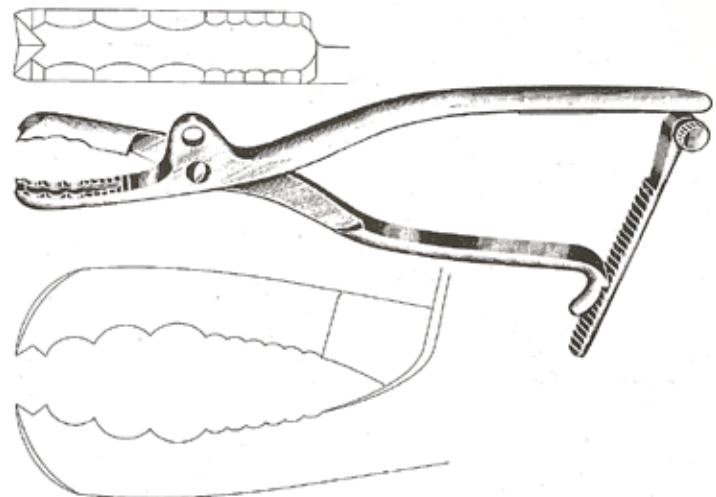

**SIMZ-023 LEWIN Bone Holding Clamp,**

• 7" (17.8cm), curved

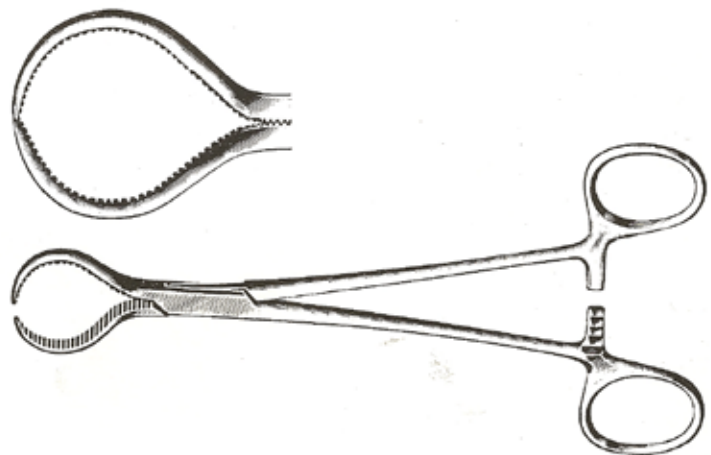

**-024 Bone Holding Clamps**  
Side angled, with speed lock

- 5 ¼" (14.6cm) For small fragment, 3mm wide jaw

**SIMZ-025**

- 7 ½" (19cm) 7mm wide jaw

**SIMZ-026**

- 9 ½" (24.1cm) 10.5mm wide jaw

**SIMZ-027**

- 10 ¼" (26cm) 11mm wide jaw

**SIMZ-028**

- 11" (28cm) 11.5mm wide jaw

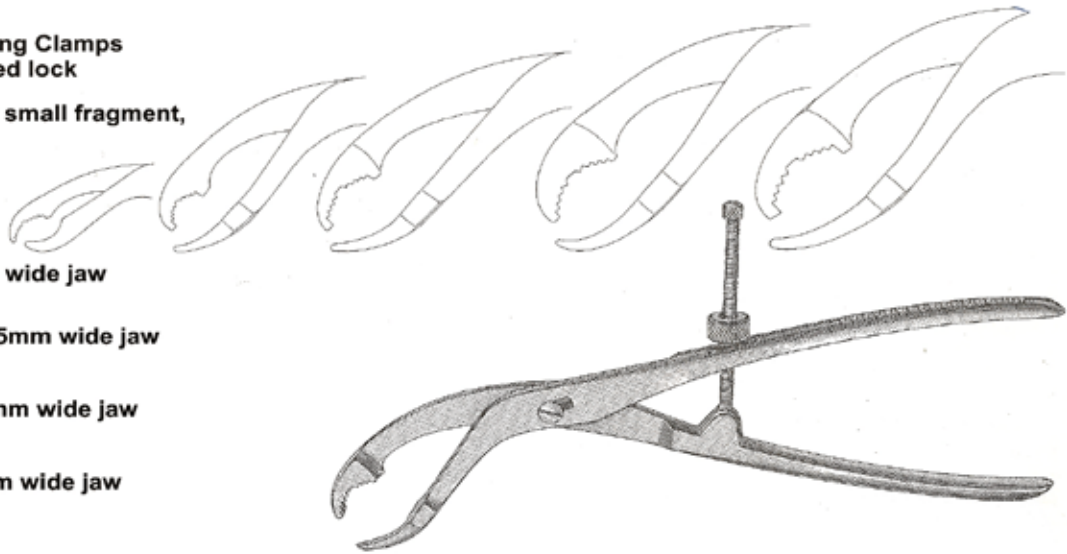

**SIMZ-029 VERBRUGGE Bone Holding Clamp,**

- 7" (17.8cm) small, 5mm wide jaw

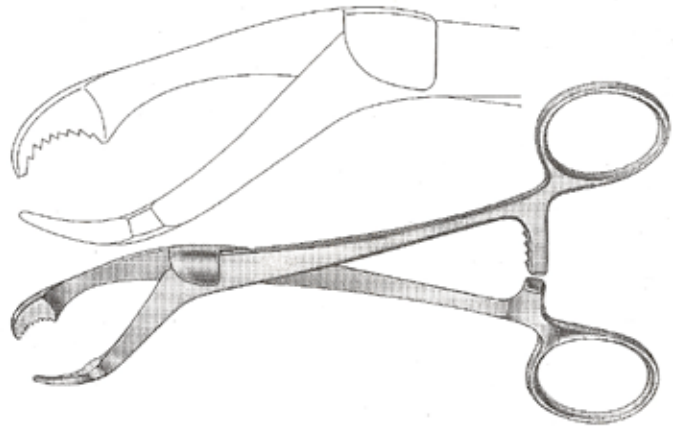

**SIMZ-030 VERBRUGGE Bone Holding Clamp,**

- 10" (25.4cm), 10mm wide jaw

**SIMZ-031**

- 10 ½" (26.7cm), 11mm wide jaw

**SIMZ-031.1**

- 10 ¾" (27.3cm), 12mm wide jaw

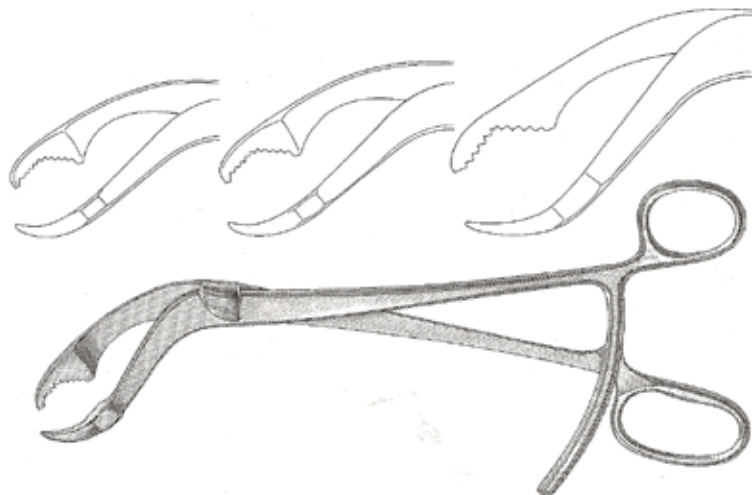



**SIMZ-032 ULRICH Style Bone Holding Clamps with speed lock**

- 7 ¼" (18.4cm) 2.5mm wide jaw

**SIMZ-033**

- 9" (22.9cm) 9mm wide jaw

**SIMZ-034**

- 10" (25.4cm) 9mm wide jaw

**SIMZ-035**

- 11" (28cm) 9mm wide jaw

**SIMZ-036**

- 11" (28cm) angled, 9mm wide jaw

**SIMZ-036.1**

- 11" (28cm) angled, swivel, 9mm wide jaw

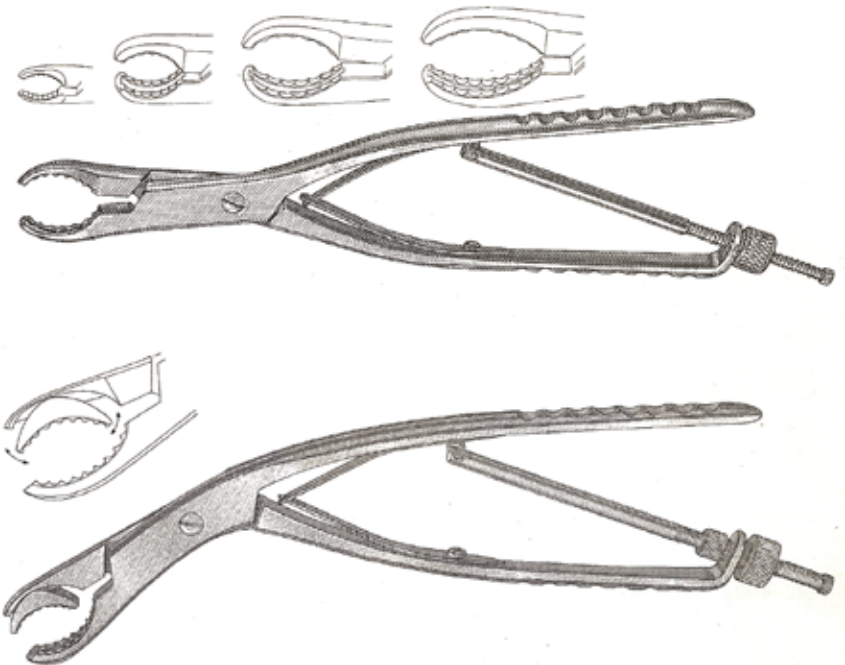

**SIMZ-037 LOWMAN Bone Holding Clamp, 1x2 prongs**

- 4 ¾" (12.1cm)

**SIMZ-038**

- 7 ¼" (18.4cm)

**SIMZ-039**

- 8" (20.3cm)

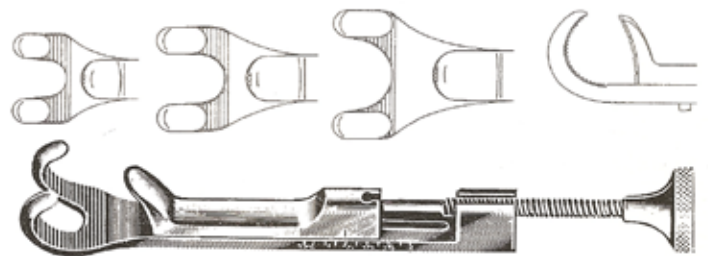

**SIMZ-040 LOWMAN Bone Holding Clamp, 1x1 prongs**

- 4 ¾" (12.1cm)

**SIMZ-041**

- 7 ¼" (18.4cm)

**SIMZ-042**

- 8" (20.3cm)

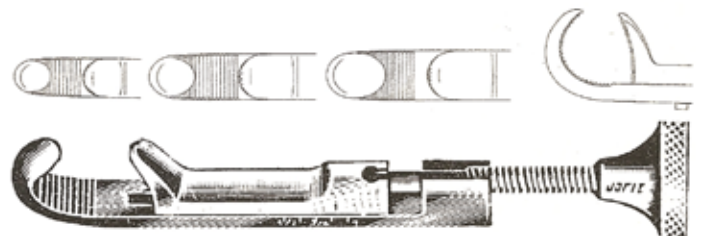

**SIMZ-043 LAMBERT-LOWMAN Bone Holding Clamp, 2x2 prongs**

- 7 ¼" (18.4cm)

**SIMZ-044**

- 8" (20.3cm)

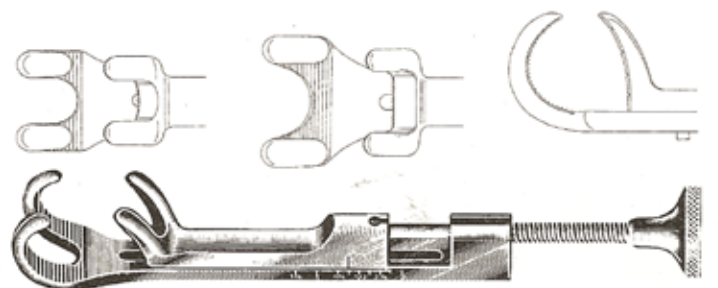

**SIMZ-045 BLUMENTHAL Rongeur**

- 7" (15.2cm) 2mm bite

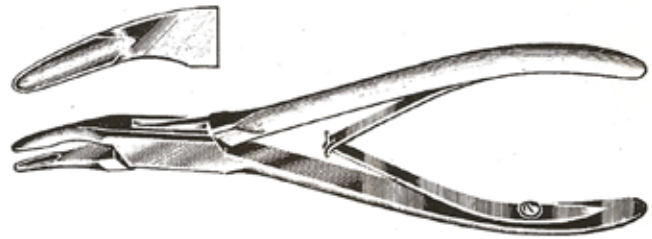

**SIMZ-046 FRIEDMAN Rongeurs 4mm bite**

- 4 1/2" (11.4cm)

**SIMZ-047**

- 5 1/4" (13.3cm)

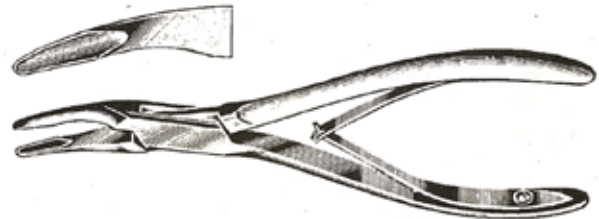

**SIMZ-048 LUER Rongeurs 7"(14.8cm), 8mm bite**

- Straight

**SIMZ-049 LUER Rongeurs 7"(14.8cm), 8mm bite**

- Curved



**SIMZ-050 SHEARER Chicken Bill Rongeur**

- 5 ½" (14cm), 3.5mm bite

**SIMZ-051**

- 6 ½" (16.5cm), 4mm bite

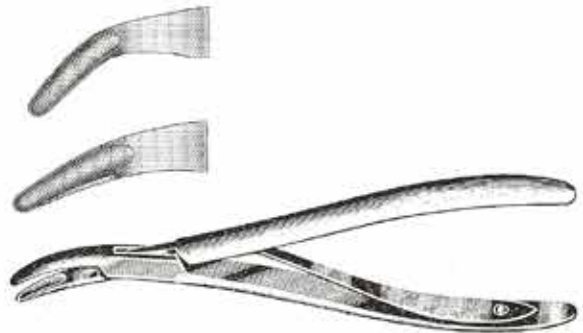

**SIMZ-052 REINER Rongeurs, 7"(17.8cm)**

- 3mm bite

**SIMZ-053**

- 4mm bite

**SIMZ-054**

- 6mm bite

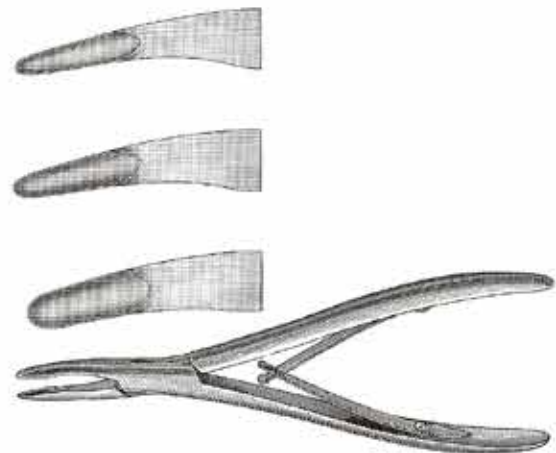

**SIMZ-055 HARTMAN Rongeurs 5 ¾"(14.6cm), 4.5mm bite**

- Straight

**SIMZ-056 HARTMAN Rongeurs 5 ¾"(14.6cm), 4.5mm bite**

- Half Curved

**SIMZ-057 HARTMAN Rongeurs 5 ¾"(14.6cm), 4.5mm bite**

- Full Curved

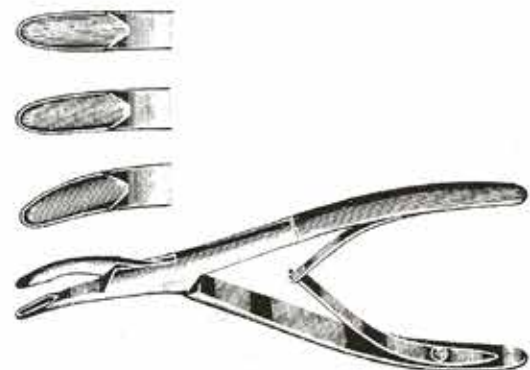

**SIMZ-058 BANE Rongeur**

- 4mm bite

**SIMZ-059**

- 5mm bite

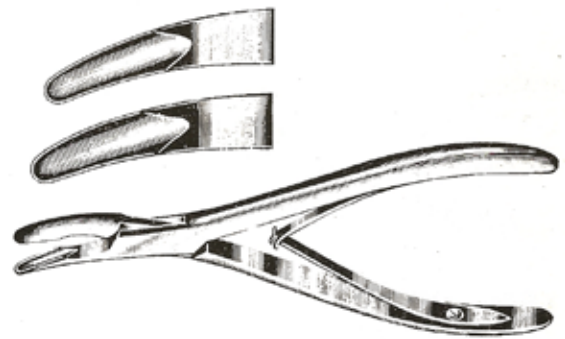

**SIMZ-060 LEMPERT Rongeurs, 2.5mm bite**

- 6 ¼" (15.9cm), Straight

**SIMZ-061**

- 6 ¼" (15.9cm), Curved

**SIMZ-062**

- 7 ½" (19.7cm), Straight

**SIMZ-063**

- 7 ½" (19.7cm), Curved



**SIMZ-064 JUERS-LEMPERT Rongeurs 7 ¼" (19.7cm), Curved Handle 3mm bite**

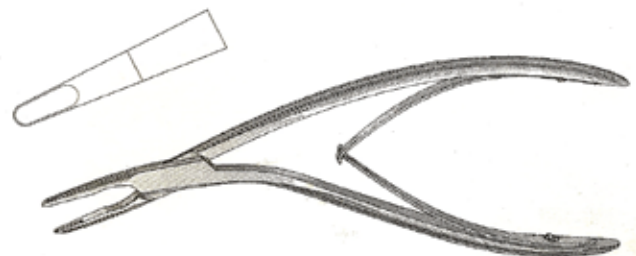

**SIMZ-065 DEAN Rongeur, 5 ¾"(14.6cm), 4mm bite**

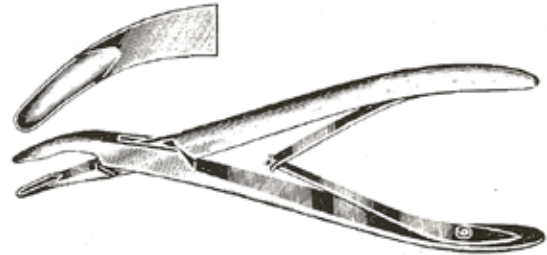

**SIMZ-066 CICHEREELLI Rongeurs, 6 ½"(16.5cm), 3.5mm bite**

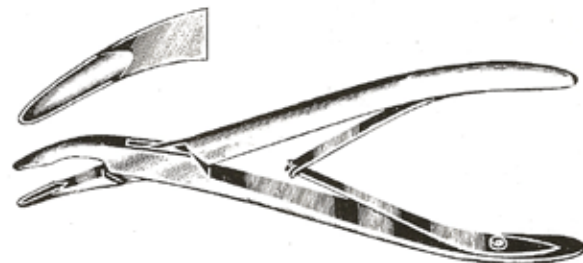

**SIMZ-067 ADSON Rongeurs, 8 ¼"(21cm)**

- 7mm bite

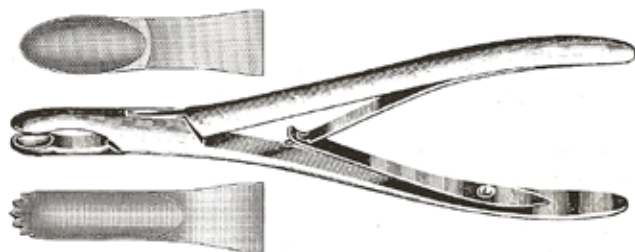

**SIMZ-068**

- 8mm bite, serrated cup jaws

**SIMZ-069 CUSHING Rongeurs 8"(20.3cm), 6mm bite**

- Straight

**SIMZ-070 CUSHING Rongeurs 8"(20.3cm), 6mm bite**

- Curved

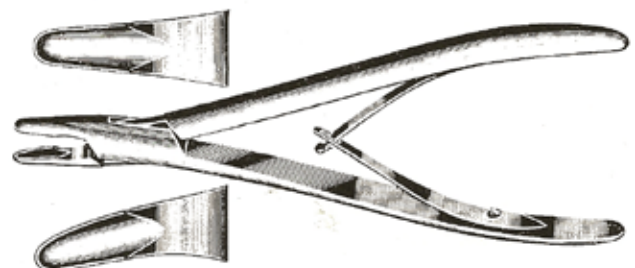



**SIMZ-071 RUSKIN Rongeurs,**

- 6"(15.2cm), Straight, 2mm bite

**SIMZ-072**

- 6"(15.2cm), Curved, 2mm bite

**SIMZ-073**

- 5 3/4"(14.6cm), Full Curved, 3mm bite

**SIMZ-074**

- 6"(15.2cm), Curved, 4mm bite

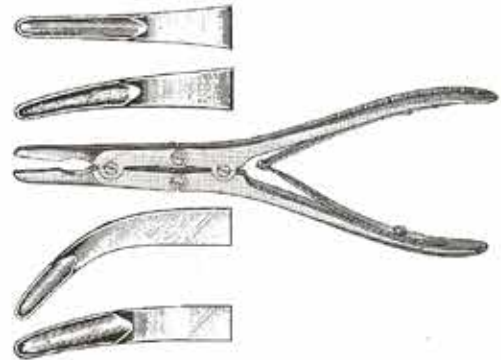

**SIMZ-075 BEYER Rongeurs, 8 1/4"(21cm)**

- 7"(17.8cm) 3mm bite



**SIMZ-076 JANSEN-ZAUFEL Rongeurs 7"(17.8cm), 4mm bite**

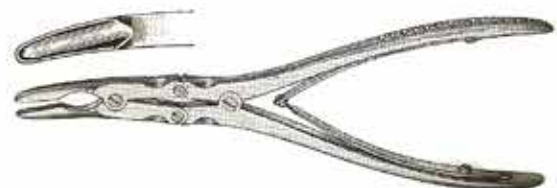

**SIMZ-077 RUSKIN Rongeurs, 7 ¼"(18.4cm),**

- Straight, 5mm bite

**SIMZ-078**

- Curved, 5mm bite

**SIMZ-079**

- Straight, 6mm bite

**SIMZ-080**

- Curved, 6mm bite

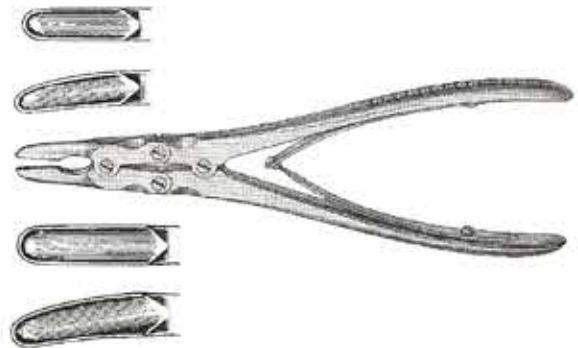

**SIMZ-081 RUSKIN-JAY Rongeurs, 8 "(20.3cm), Heavu Duty, Curved, 6mm Bite**



**SIMZ-082 RUSKIN Angular Duckbill Rongeurs 7 ¼"(18.4cm), 6mm bite**

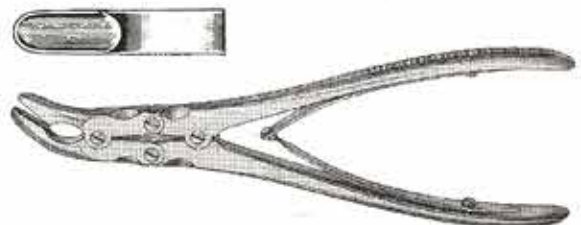

**SIMZ-083 STILLE-LUER Rongeurs, Straight, 10mm bite**

• 8 ½"(21.6cm)

**SIMZ-084**

• 10 ½"(26.7cm)

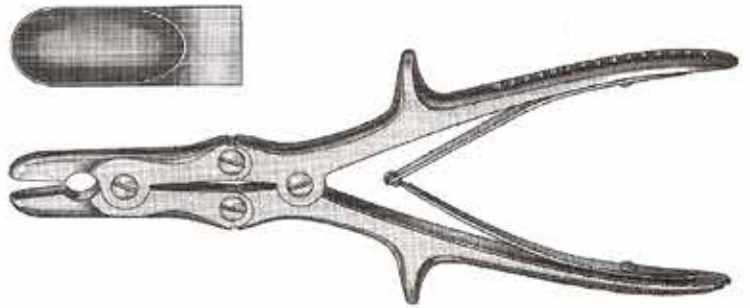

**SIMZ-085 STILLE-LUER Rongeurs, Curved, 10mm bite**

• 8 ½"(21.6cm)

**SIMZ-086**

• 10 ½"(26.7cm)

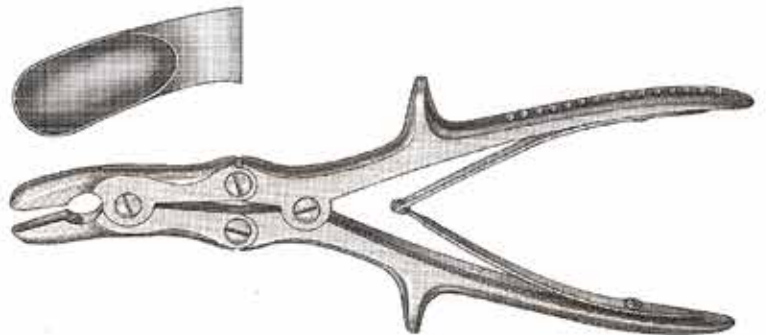

**SIMZ-087 STILLE-LUER Angular Duckbill Rongeurs 7 ¼"(18.4cm), 6mm bite**



**SIMZ-088** ECHLIN Angular Duckbill Rongeurs,  
9"(22.8cm)

•2mm bite

**SIMZ-089**

•3mm bite

**SIMZ-090**

•4mm bite

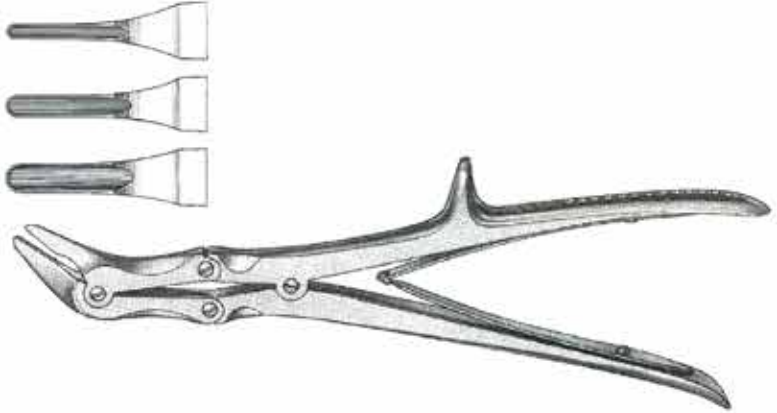

**SIMZ-091** ECHLIN Angular Duckbill Rongeurs,  
9"(22.8cm) 6mm Bite



**SIMZ-092** LEKSELL Rongeurs,  
Straight curve, 9"(22.8cm)

• 3mm bite

**SIMZ-093**

•8mm bite

**SIMZ-094**

•5mm bite



**SIMZ-095** LEKSELL Rongeurs,  
Full curve, 9"(22.8cm)

• 3mm bite

**SIMZ-096**

•8mm bite

**SIMZ-097**

•5mm bite

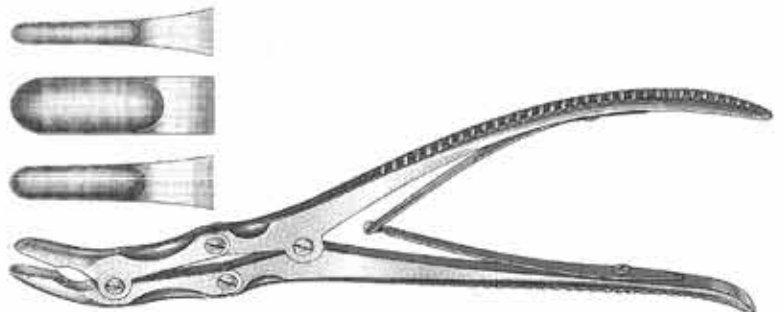

**SIMZ-098 SMITH-PETERSEN Leminectomy Rongeurs,**  
9 1/2"(24.1cm) 3.5mm bite

- Straight



**SIMZ-099**

- Half curved



**SIMZ-099.1**

- Full curved



**SIMZ-100 SAUERBRUCH Rib Rongeurs,**  
11 1/2"(29.2cm) Square bite

- 5/8"(1.6cm) wide jaw

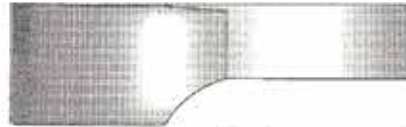

**SIMZ-101**

- 3/4"(1.9cm) wide jaw

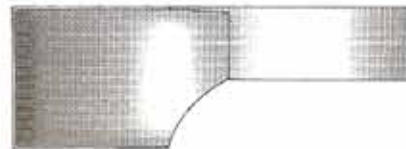
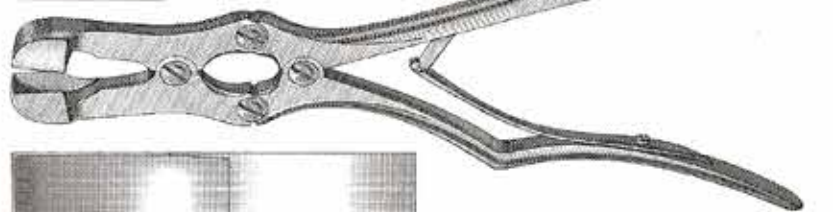

**SIMZ-102 DALE Thoracic Rongeurs**  
14 1/2"(36.8cm), 3mm bite





**SIMZ-103 LISTON Bone Cutting Forceps,**  
5 3/4" (14.6cm)

•Straight

SIMZ-104

•Up-Angled

SIMZ-105

•Down-Curved

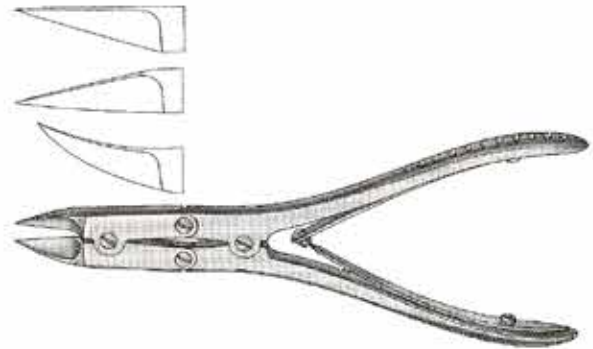

**SIMZ-106 RUSKIN-LISTON Bone Cutting Forceps,**  
7 1/4" (18.4cm)

•Straight

SIMZ-107

•Up-Angled

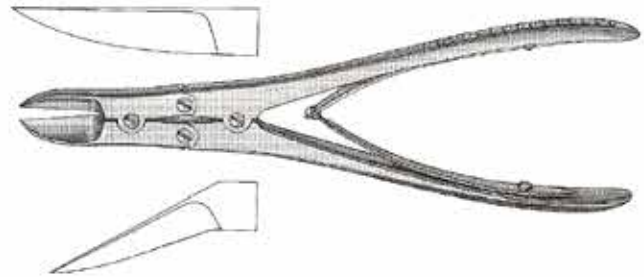

**SIMZ-108 RUSKIN-LISTON Bone Splitting Forceps,**  
7 1/4" (18.4cm) narrow jaw

•Straight

SIMZ-109

•Up-Angled

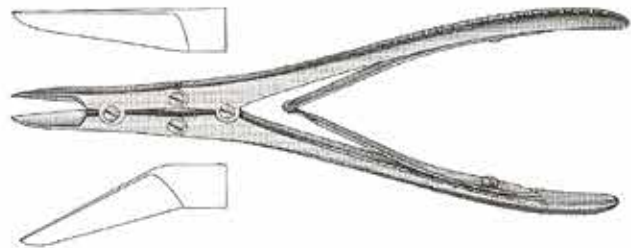

**SIMZ-110 LITTAUER-LISTON Bone Cutting Forceps,**  
6" (15.3cm)



**SIMZ-111 STILLE-LISTON Bone Cutting Forceps 10 ½" (26.7)**

- Straight

**SIMZ-112**

- Up-Angled

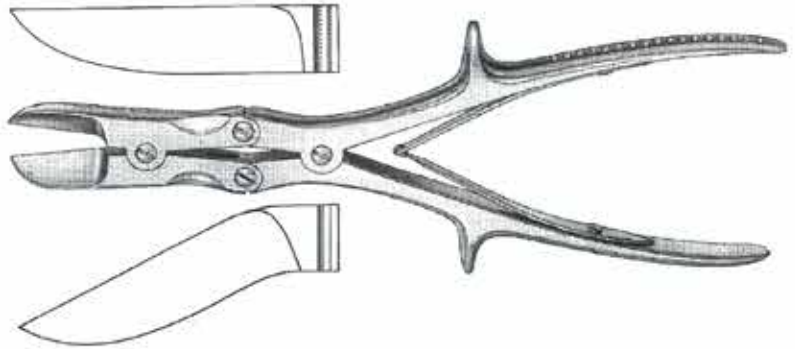

**SIMZ-113 STILLE-HORSLEY Rongeurs, 10" (25.4cm) S-SHAPED**

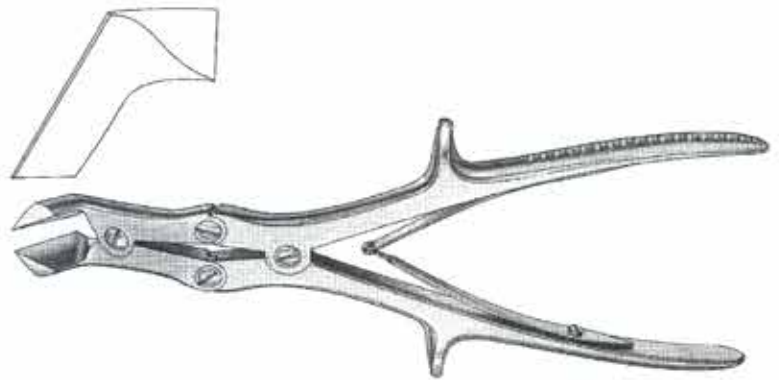

**SIMZ-114 LISTON Bone Cutting Forceps**

- 5 ½" (14cm) straight

**SIMZ-115**

- 6 ½" (16.5cm) straight

**-116**

- 7 ½" (19.1cm) straight

**SIMZ-118**

- 6 ½" (16.5cm) up-angled

**SIMZ-117**

- 5 ½" (14cm) up-angled

**SIMZ-118.1**

- 7 ½" (19.1cm) up-angled

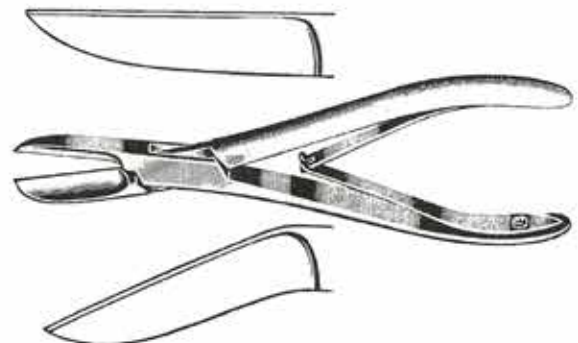

**SIMZ-119 BENNETT Tibia Retractors 10"(25.4cm)**

- 1 3/4"(4.4cm) narrow blade

**SIMZ-120**

- 2 3/4"(6cm) narrow blade

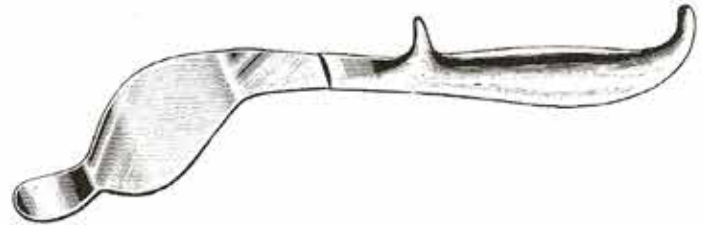

**SIMZ-121 BLOUNT Knee Retractors 7"(17.8cm)**



**SIMZ-122 BLOUNT Retractors  
10 1/2"(26.7cm), single prong  
1 1/2"(3.8cm), wide blade**

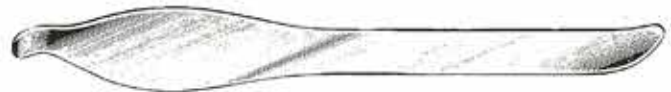

**SIMZ-123 BLOUNT Retractors  
10 1/2"(26.7cm), double prong  
1 3/8"(4.1cm), wide blade**



**SIMZ-124 LISTON Amputating Knives**

- 6 1/2"(16.5cm) Blade

**SIMZ-125**

- 8 1/2"(21.6cm) Blade



**SIMZ-126 MURPHY-LANE Bone Skid**  
12"(30.5cm)



**SIMZ-127 MEYERDING Hip and Shoulder Skid**  
13"(33cm)



**SIMZ-128 SMILLE Retractors**

- 5 1/2"(14cm) Reserve Curved,  
1/2" wide x 2 1/8" long blade (1.3cm x 5.4cm)

**SIMZ-128.1**

- 5 1/2"(14cm) Angled  
3/4" wide x 1 3/8" long blade (1.9cm x 3.5cm)

**SIMZ-128.2**

- 5 1/2"(114cm) Angled  
3/4" wide x 2" long blade (1.9cm x 5.1cm)

**SIMZ-128.3**

- 5 1/2"(14cm) Angled  
3/4" wide x 2 3/8" long blade (1.9cm x 6cm)

**SIMZ-128.4**

- 5 1/2"(114cm) Curved  
1/2" wide x 5/8" long blade (1.3cm x 1.6cm)

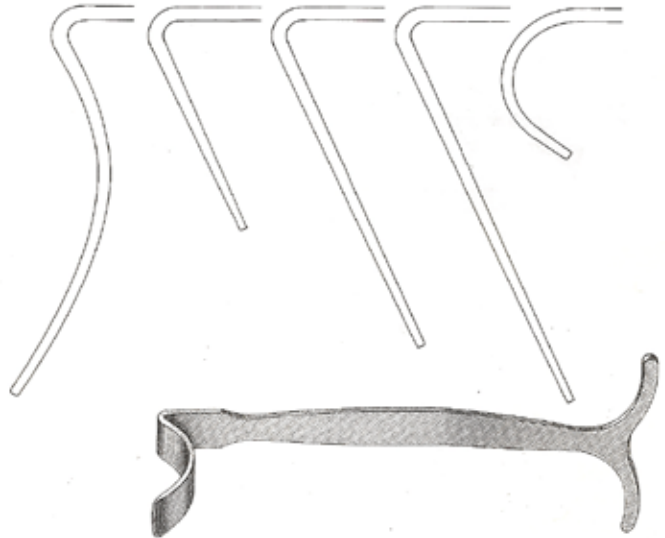

**SIMZ-129 HAYES Hand Retractors**

- 5 1/4"(13.3cm) Blade 1/2" x 1/2" (1.3cm x 3.8cm)

**SIMZ-129.1**

- 6 1/4"(16cm) Blade 1/2" x 1/2" (1.3cm x 3.8cm)

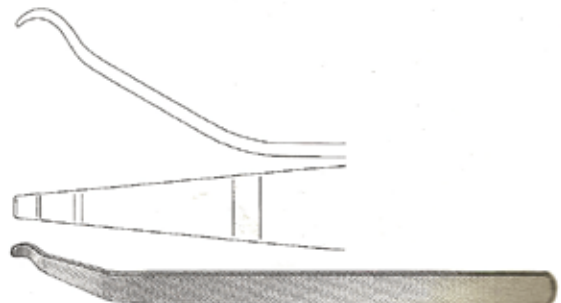

**SIMZ-130 MINI-HOHMANN Retractors 6 ¼"(15.9CM)**

- 6mm wide blade

**SIMZ-130.1**

- 8mm wide blade

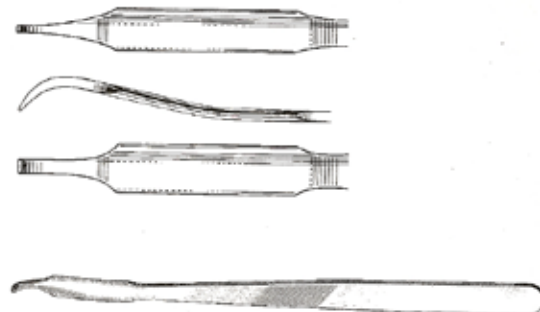

**SIMZ-131 HOHMANN Retractors**

- 9 ¼ "(23.5cm), 10mm wide blade

**SIMZ-132**

- 9 ¼ "(23.5cm), 18mm wide blade

**SIMZ-133**

- 9 ¼ "(23.5cm), 25mm wide blade

**SIMZ-134**

- 9 ¼ "(23.5cm), 43mm wide blade

**SIMZ-136**

- 9 ¾ "(23.5cm), 70mm wide blade



**SIMZ-137 AUFRANC Cobra Retractors, 10 ¼" (26cm), 32mm wide blade**

- Pointed Tip, Serrated

**SIMZ-138**

- Blunt, Tip, Serrated

**SIMZ-139**

- Blunt, Tip, Smooth





**SIMZ-140 DEEP RAKE Retractors Lamb handle, 11"(28cm), 4 blunt prongs, 2 ¼" wide(5.7cm)**

**SIMZ-141**

- ½ " deep (3.8cm)

**SIMZ-142**

- 2" deep (5.1cm)

**SIMZ-143**

- 2 ½" deep (6.4cm)

**SIMZ-144**

- 3" deep (7.6cm)

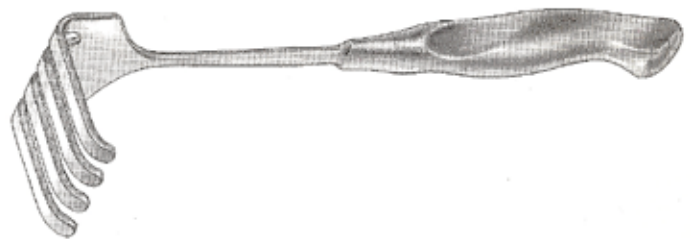

**SIMZ-145 INITIAL INCISION Retractor**

includes:

Frame (225-499) 2 blades (225-502) and (225-503) and weight on chain (225-504)

**SIMZ-146**

- Frame only

**SIMZ-147**

- Short Blade: 1" wide x 1 ¼ deep (2.5cm x 3.2cm)

**SIMZ-148**

- Long Blade: 1" wide x 1 ½" deep (2.5cm x 3.8cm)

**SIMZ-149**

- Short Blade: 1" wide x 3" deep (2.5cm x 7.6cm)

**SIMZ-150**

- Long Blade: 1" wide x 3" deep (2.5cm x 7.6cm)

**SIMZ-151**

- Short Blade: 1" wide x 4" deep (2.5cm x 10.1cm)

**SIMZ-152**

- Long Blade: 1" wide x 4" deep (2.5cm x 10.1cm)

**SIMZ-153**

- Short Blade: 1" wide x 5" deep (2.5cm x 12.7cm)

**SIMZ-154**

- Long Blade: 1" wide x 5" deep (2.5cm x 12.7cm)

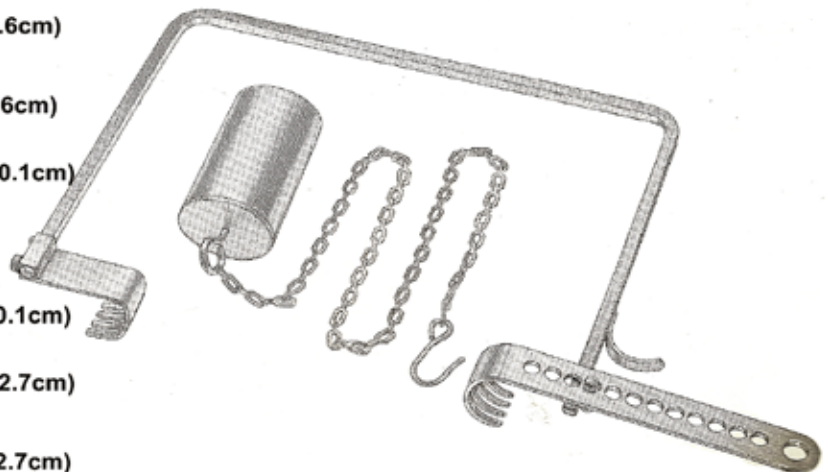

**BRUNS Oval Cup Currettes,  
Straight**

**6 3/4" (17.1cm)      8" (20.3cm)      9" (22.9cm)**

- SIMZ-155 • Size 5-0 SIMZ-168 • Size 5-0 SIMZ-179 • Size 5-0
- SIMZ-156 • Size 4-0 SIMZ-169 • Size 4-0 SIMZ-180 • Size 4-0
- SIMZ-157 • Size 3-0 SIMZ-170 • Size 3-0 SIMZ-181 • Size 3-0
- SIMZ-158 • Size 2-0 SIMZ-171 • Size 2-0 SIMZ-182 • Size 2-0
- SIMZ-159 • Size 0 SIMZ-172 • Size 0 SIMZ-183 • Size 0
- SIMZ-160 • Size 1 SIMZ-173 • Size 1 SIMZ-184 • Size 1
- SIMZ-161 • Size 2 SIMZ-174 • Size 2 SIMZ-185 • Size 2
- SIMZ-162 • Size 3 SIMZ-175 • Size 3 SIMZ-186 • Size 3
- SIMZ-163 • Size 4 SIMZ-176 • Size 4 SIMZ-187 • Size 4
- SIMZ-164 • Size 5 SIMZ-177 • Size 5 SIMZ-188 • Size 5
- SIMZ-165 • Size 6 SIMZ-178 • Size 6 SIMZ-189 • Size 6

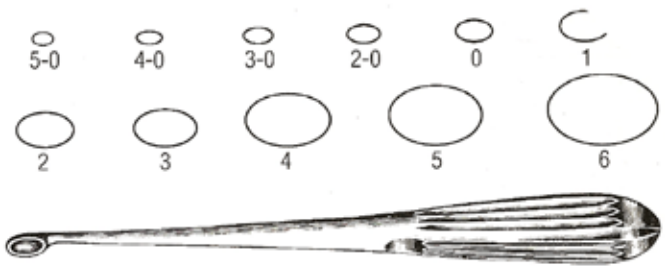

**BRUNS Oval Cup Currettes,  
Angled tip**

**8" (20.3cm)      9" (22.9cm)**

- SIMZ-190 • Size 5-0 SIMZ-201 • Size 5-0
- SIMZ-191 • Size 4-0 SIMZ-202 • Size 4-0
- SIMZ-192 • Size 3-0 SIMZ-203 • Size 3-0
- SIMZ-193 • Size 2-0 SIMZ-204 • Size 2-0
- SIMZ-194 • Size 0 SIMZ-205 • Size 0
- SIMZ-195 • Size 1 SIMZ-206 • Size 1
- SIMZ-196 • Size 2 SIMZ-207 • Size 2
- SIMZ-197 • Size 3 SIMZ-208 • Size 3
- SIMZ-198 • Size 4 SIMZ-209 • Size 4
- SIMZ-199 • Size 5 SIMZ-210 • Size 5
- SIMZ-200 • Size 6 SIMZ-211 • Size 6

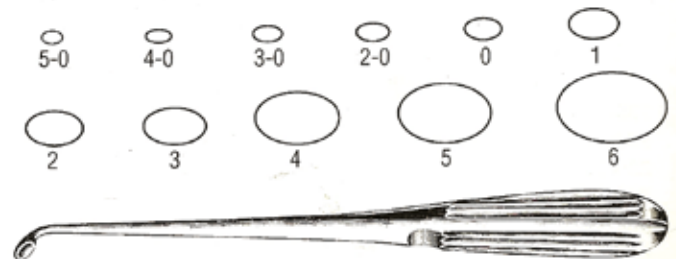

**SPINAL Fusion Curettes,  
9"(22.9cm), reverse angle**

**6 3/4" (17.1cm)**

- SIMZ-212 • Size 5-0
- SIMZ-213 • Size 4-0
- SIMZ-214 • Size 3-0
- SIMZ-215 • Size 2-0
- SIMZ-216 • Size 0
- SIMZ-217 • Size 1
- SIMZ-218 • Size 2
- SIMZ-219 • Size 3
- SIMZ-220 • Size 4
- SIMZ-221 • Size 5
- SIMZ-222 • Size 6

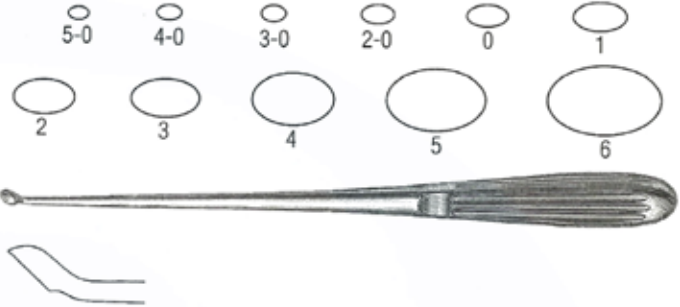

**BRUNS Oval Cup Curettes,  
9"(22.9cm), Straight solid hexagonal handle**

- SIMZ-223 • Size 3-0
- SIMZ-224 • Size 2-0
- SIMZ-225 • Size 0
- SIMZ-226 • Size 1
- SIMZ-227 • Size 2
- SIMZ-228 • Size 3
- SIMZ-229 • Size 4
- SIMZ-230 • Size 5
- SIMZ-231 • Size 6

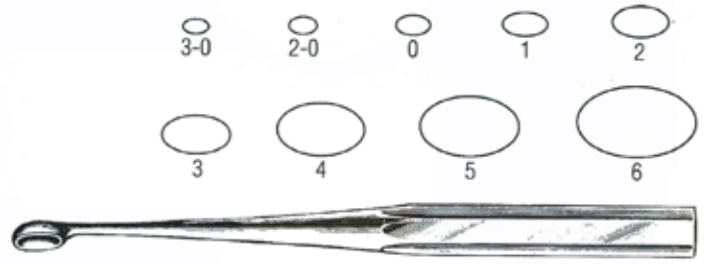

**SEMMES (HOWARD) Spinal Curettes,  
9"(22.9cm), 4x7 mm Cup**

- SIMZ-232 • Straight
- SIMZ-233 • Straight Angle
- SIMZ-234 • Acute Angle

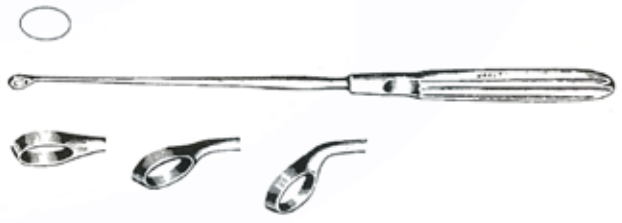

**COBB-Type Oval Cup Curettes,  
11"(29.7cm), hollow knurled handle**

- | Straight            | Angle Tip           |
|---------------------|---------------------|
| SIMZ-235 • Size 3-0 | SIMZ-244 • Size 3-0 |
| SIMZ-236 • Size 2-0 | SIMZ-245 • Size 2-0 |
| SIMZ-237 • Size 0   | SIMZ-246 • Size 0   |
| SIMZ-238 • Size 1   | SIMZ-247 • Size 1   |
| SIMZ-239 • Size 2   | SIMZ-248 • Size 2   |
| SIMZ-240 • Size 3   | SIMZ-249 • Size 3   |
| SIMZ-241 • Size 4   | SIMZ-250 • Size 4   |
| SIMZ-242 • Size 5   | SIMZ-251 • Size 5   |
| SIMZ-243 • Size 6   | SIMZ-251 • Size 6   |

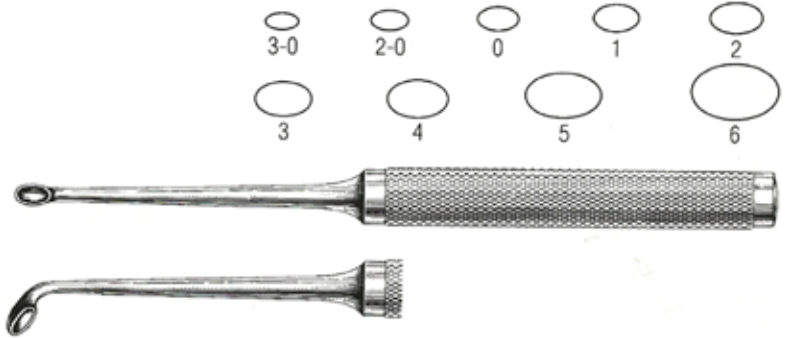

**Bone Hooks,  
9"(22.9cm),**

- SIMZ-253 • 3/8"(9.5mm) hook
- SIMZ-254 • 3/4"(19mm) hook
- SIMZ-255 • 1"(25mm) hook

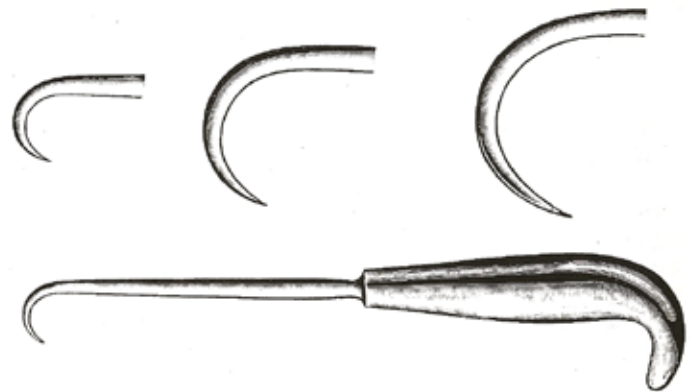

**VOLKMAN Bone Curettes,  
double ended**

- SIMZ-256 • 5"(12.7cm), one round and one oval cup, 10.5mm and 6.3mm x 6.8mm
- SIMZ-257 • 6 1/2 "(16.5cm), two oval cup, 7.5mm x 14mm and 9mm x 22mm
- SIMZ-258 • 6 1/2 "(16.5cm), one round and one oval cup, 14mm and 7mm x 9mm
- SIMZ-259 • 8 "(20.3cm), one round and one oval cup, 17.5mm and 9mm x 11mm



**SCOVILLE DISC Curettes,  
10"(25.4cm), 4x 10mm cup**

- SIMZ-260 • Straight
- SIMZ-261 • Reverse Angled
- SIMZ-262 • Angled



**CONE Ring Curettes,  
8 5/8" (21.9cm),**

- SIMZ-263 • Straight, Size 1, 8mm diameter
- SIMZ-264 • Straight, Size 2, 6mm diameter
- SIMZ-265 • Straight, Size 3, 3mm diameter
- SIMZ-266 • Angular, Size 1, 8mm diameter
- SIMZ-267 • Angular, Size 2, 6mm diameter
- SIMZ-268 • Angular, Size 3, 3mm diameter

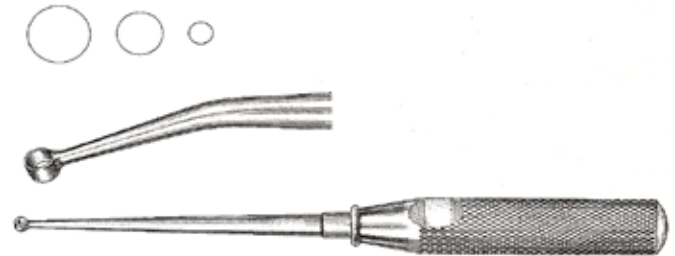

**CONE Ring-Curettes,  
9" (22.9cm), 8mm cup**

- SIMZ-269 • 5° Angle
- SIMZ-270 • 30° Angle

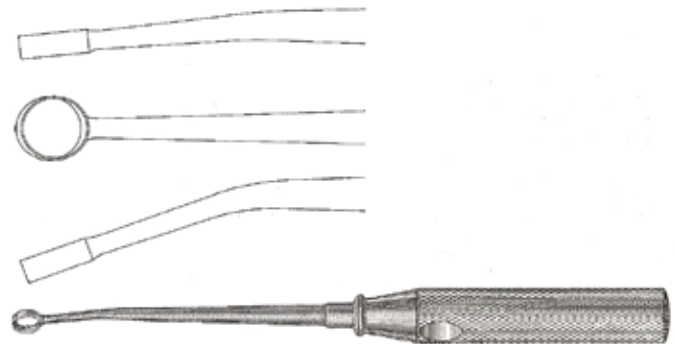

**EPSTEIN Spinal Fusion Curettes,  
8" (20.3cm), reverse angle**

- SIMZ-271 • Size 3-0
- SIMZ-272 • Size 2-0
- SIMZ-273 • Size 0





Wire Cutters, Up angled,  
CARB-EDGE jaws

**SIMZ-274** • 7" (17.8cm)  
maximum capacity-  
.067" (1.7mm)

**SIMZ-275** • 8 1/2" (21.6cm)  
maximum capacity-  
.098" (2.5mm)

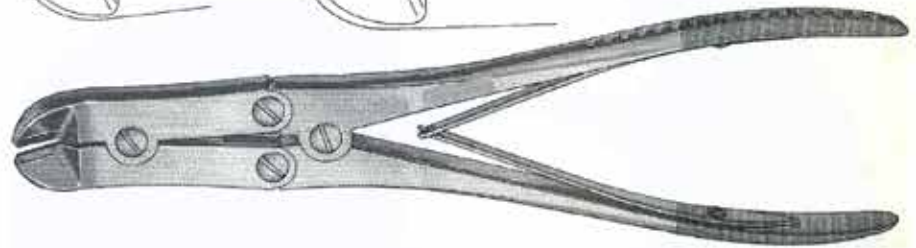
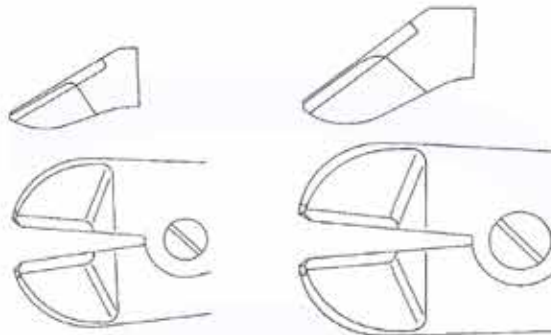

**SIMZ-276** Flush Wire Cutter,  
7" (17.8cm) CARB-EDGE jaws,  
maximum capacity .067" (1.7mm)

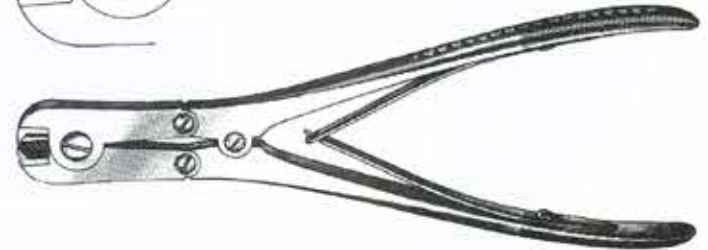

**SIMZ-277** Wire Cutter,  
7" (17.8cm),  
side cutting, CARB-EDGE jaws,  
maximum capacity .059" (1.5mm)

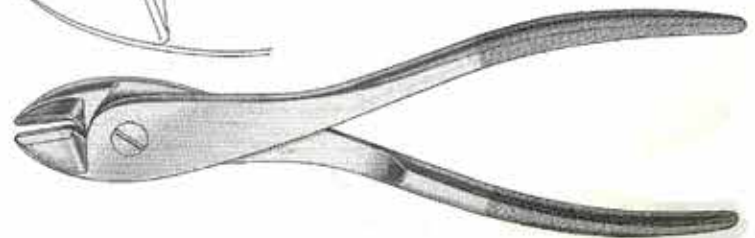
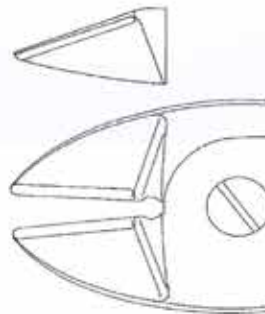

**SIMZ-278 Cannulated Pin Cutter,**  
7 1/2" (19cm) end-cutting,  
maximum capacity .062" (1.6mm)

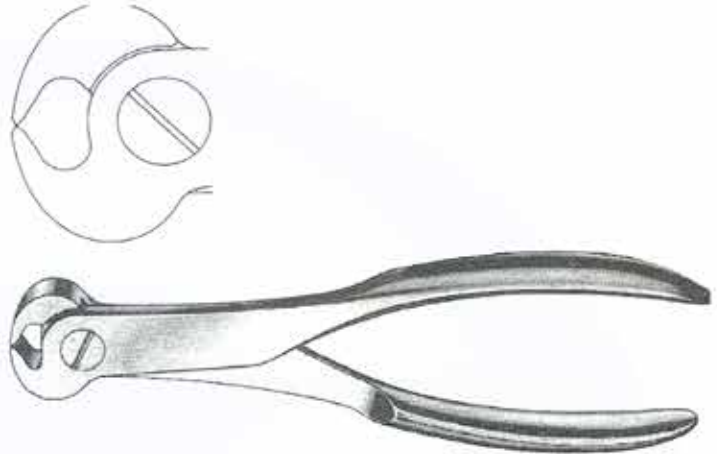

**SIMZ-279 Large Pin Cutter,**  
22" (55.6cm), cuts rods up to .250" (6.3mm)  
toggle joint transfers leverage to the cutting blades

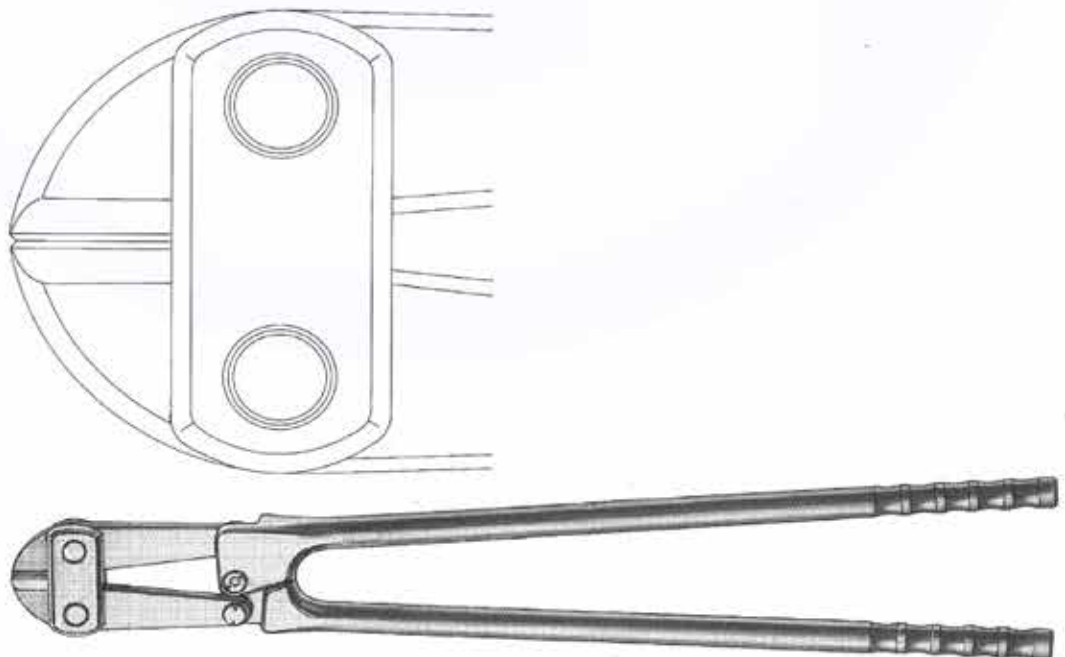

**SIMZ-280 Slip Joint Adjustable Pliers,**  
7 3/4"(19.7cm)



**SIMZ-281 Parallel pliers,**  
7"(17.8cm), grooved 10mm wide jaws  
for pin removal

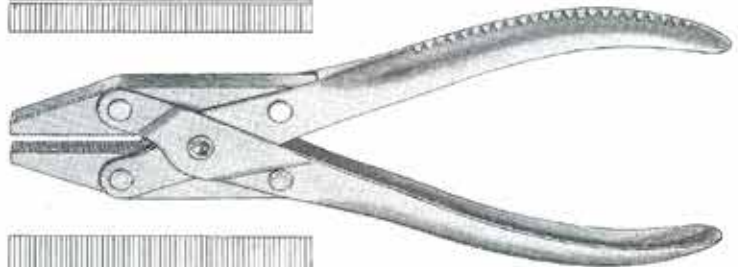

**SIMZ-282 Parallel pliers with Side Cutter,**  
7"(17.8cm), grooved 10mm wide jaws  
for pin removal,  
Maximum capacity .062" (1.6mm)



**SIMZ-283 Needle Nose Pliers,**  
5 1/8" (13cm), grooved jaws,  
tips taper to 1mm

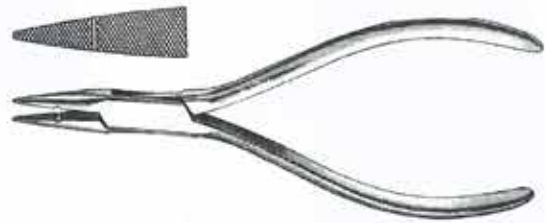

**SIMZ-284 Flat Nose Pliers,**  
6" (15.2cm), tips taper to 2mm

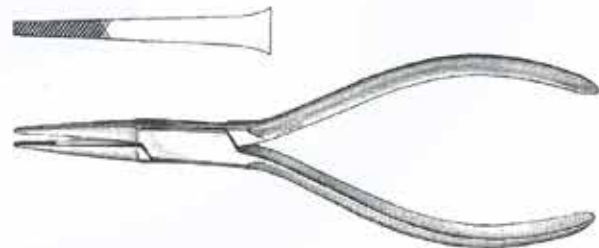

**SIMZ-285 Flat Nose Pliers,**  
6 1/2" (16.5cm) side cutting blades,  
tips taper to 3.5mm

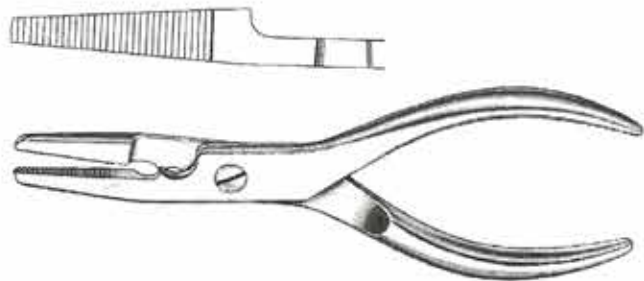

Heavy Duty Locking Pliers,  
reinforced jaw hinge,  
self-locking lever with adjustment screw  
and one handed quick release

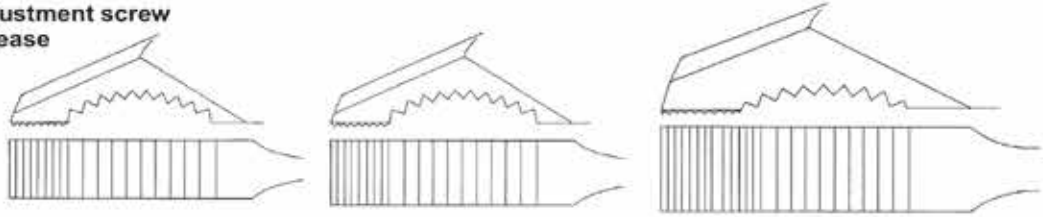

- SIMZ-286 • 6 3/4" (17.1cm), 7mm wide tip
- SIMZ-287 • 8" (20.3cm), 9mm wide tip
- SIMZ-288 • 9 1/2" (24.1cm), 13mm wide tip



Heavy Duty Locking Pliers,  
reinforced jaw hinge,  
self-locking lever with adjustment screw  
and one handed quick release

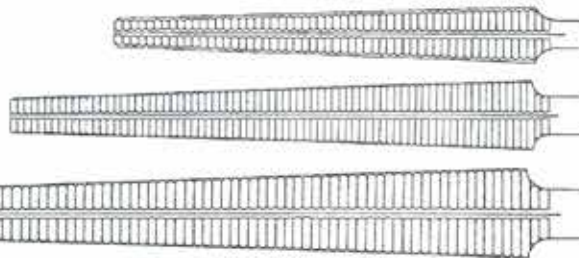

- SIMZ-289 • 8 3/4" (21.9cm), 5mm wide tip
- SIMZ-290 • 9 1/2" (24.1cm), 5mm wide tip
- SIMZ-291 • 11 1/2" (29.2cm), 7mm wide tip

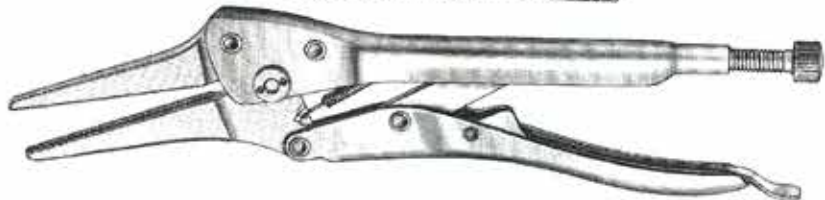

SIMZ-292 TOWNLEY Femur Caliper,  
4 1/2" (11.4cm)

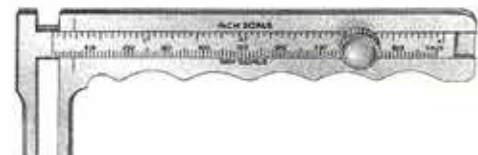



**SIMZ-293 Bone Drill**

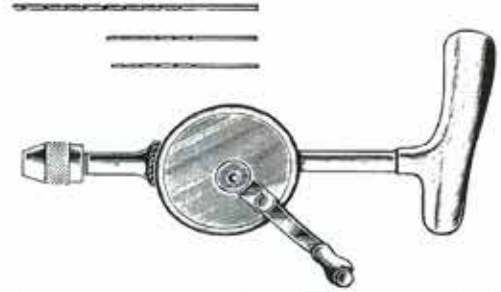

**SIMZ-294 Hand Drill**  
10" cannulated, 3-jaw stainless jacobs chuck,  
accepts wire/pin up to 6.35mm (1/4")  
aluminum body with offset handle

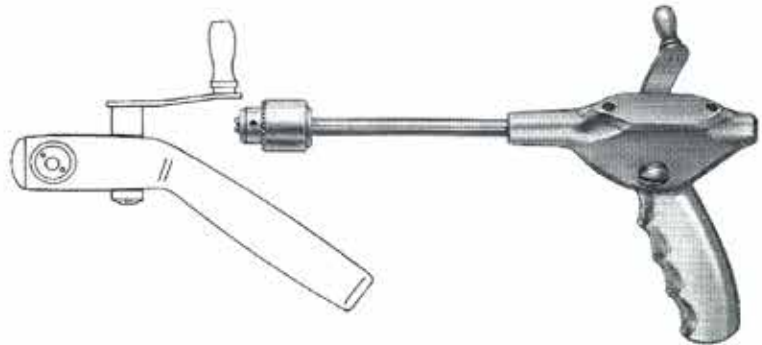

**SIMZ-295 Hand Drill**  
6" cannulated, 3-jaw stainless jacobs chuck,  
accepts wire/pin up to 6.35mm (1/4")  
aluminum body with offset handle

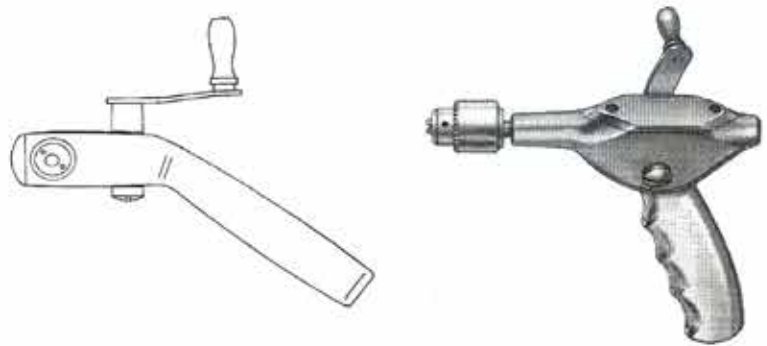

**SIMZ-296 Hand Drill,**  
with jacobs chuck

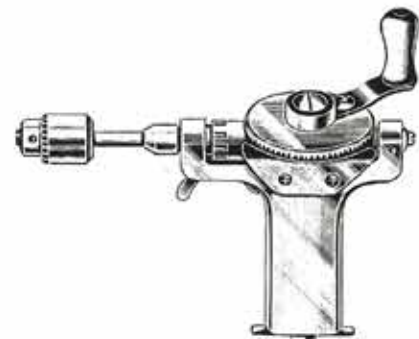

**HIBBS Chisels,  
9 ½ (24.1cm), straight**

- SIMZ-297 • ¼" (6mm)
- SIMZ-298 • ⅜" (9mm)
- SIMZ-299 • ½" (12mm)
- SIMZ-300 • ⅝" (16mm)
- SIMZ-301 • ¾" (19mm)
- SIMZ-302 • ⅞" (22mm)
- SIMZ-303 • 1" (25mm)
- SIMZ-304 • 1 ⅛" (29mm)
- SIMZ-305 • 1 ¼" (32mm)
- SIMZ-306 • 1 ½" (38mm)



**HIBBS Chisels,  
9 ½ (24.1cm), curved**

- SIMZ-307 • ¼" (6mm)
- SIMZ-308 • ⅜" (9mm)
- SIMZ-309 • ½" (12mm)
- SIMZ-310 • ⅝" (16mm)
- SIMZ-311 • ¾" (19mm)
- SIMZ-312 • ⅞" (22mm)
- SIMZ-313 • 1" (25mm)
- SIMZ-314 • 1 ⅛" (29mm)
- SIMZ-315 • 1 ¼" (32mm)
- SIMZ-316 • 1 ½" (38mm)



**HIBBS Osteotomes,  
9 ½ (24.1cm), straight**

- SIMZ-317 • ¼" (6mm)
- SIMZ-318 • ⅜" (9mm)
- SIMZ-319 • ½" (12mm)
- SIMZ-320 • ⅝" (16mm)
- SIMZ-321 • ¾" (19mm)
- SIMZ-322 • ⅞" (22mm)
- SIMZ-323 • 1" (25mm)
- SIMZ-324 • 1 ⅛" (29mm)
- SIMZ-325 • 1 ¼" (32mm)
- SIMZ-326 • 1 ½" (38mm)



**HIBBS Ostetomes,  
9 ½ (24.1cm), curved**

- SIMZ-327 • ¼" (6mm)
- SIMZ-328 • ⅜" (9mm)
- SIMZ-329 • ½" (12mm)
- SIMZ-330 • ⅝" (16mm)
- SIMZ-331 • ¾" (19mm)
- SIMZ-332 • ⅞" (22mm)
- SIMZ-333 • 1" (25mm)
- SIMZ-334 • 1 ⅛" (29mm)
- SIMZ-335 • 1 ¼" (32mm)
- SIMZ-336 • 1 ½" (38mm)



**HIBBS Gouges,  
9 ½ (24.1cm), straight**

- SIMZ-337 • ¼" (6mm)
- SIMZ-338 • ⅜" (9mm)
- SIMZ-339 • ½" (12mm)
- SIMZ-340 • ⅝" (16mm)
- SIMZ-341 • ¾" (19mm)
- SIMZ-342 • ⅞" (22mm)
- SIMZ-343 • 1" (25mm)
- SIMZ-344 • 1 ⅛" (29mm)
- SIMZ-345 • 1 ¼" (32mm)
- SIMZ-346 • 1 ½" (38mm)



**HIBBS Gouges,  
9 ½ (24.1cm), curved**

- SIMZ-347 • ¼" (6mm)
- SIMZ-348 • ⅜" (9mm)
- SIMZ-349 • ½" (12mm)
- SIMZ-350 • ⅝" (16mm)
- SIMZ-351 • ¾" (19mm)
- SIMZ-352 • ⅞" (22mm)
- SIMZ-353 • 1" (25mm)
- SIMZ-354 • 1 ⅛" (29mm)
- SIMZ-355 • 1 ¼" (32mm)
- SIMZ-356 • 1 ½" (38mm)



**SMITH PETERSEN Ostetomes,  
8" (20.3cm), Straight**

- SIMZ-357 • ¼" (6mm)
- SIMZ-358 • ⅜" (9mm)
- SIMZ-359 • ½" (12mm)
- SIMZ-360 • ⅝" (16mm)
- SIMZ-361 • ¾" (19mm)
- SIMZ-362 • 1" (25mm)
- SIMZ-365 • 1 ¼" (32mm)



**SMITH PETERSEN Ostetomes,  
8" (20.3cm), Curved**

- SIMZ-366 • ¼" (6mm)
- SIMZ-367 • ⅜" (9mm)
- SIMZ-368 • ½" (12mm)
- SIMZ-369 • ⅝" (16mm)
- SIMZ-370 • ¾" (19mm)
- SIMZ-371 • 1" (25mm)
- SIMZ-372 • 1 ¼" (32mm)



**SMITH PETERSEN Gouges,  
8" (20.3cm), Straight**

- SIMZ-373 • ¼" (6mm)
- SIMZ-374 • ⅜" (9mm)
- SIMZ-375 • ½" (12mm)
- SIMZ-376 • ⅝" (16mm)
- SIMZ-377 • ¾" (19mm)
- SIMZ-378 • 1" (25mm)
- SIMZ-379 • 1 ¼" (32mm)



**SMITH PETERSEN Gouges,  
8" (20.3cm), Curved**

- SIMZ-380 • ¼" (6mm)
- SIMZ-381 • ⅜" (9mm)
- SIMZ-382 • ½" (12mm)
- SIMZ-383 • ⅝" (16mm)
- SIMZ-384 • ¾" (19mm)
- SIMZ-385 • 1" (25mm)
- SIMZ-386 • 1 ¼" (32mm)



**SIMZ-387 COBB-Type Spinal Gouge,**  
11" (28cm), Straight,  
9/32" (7.5mm) wide



**SIMZ-388 COBB-Type Spinal Gouge,**  
11" (28cm), Medium Curved,  
9/32" (7.5mm) wide



**SIMZ-389 COBB-Type Spinal Gouge,**  
11" (28cm), Strong Curved,  
9/32" (7.5mm) wide



**SIMZ-390 COBB-Type Spinal Gouge,**  
11" (28cm), Reversed Curved,  
9/32" (7.5mm) wide





**COBB-Type Spinal Gouge,  
9 1/2" (24cm), Hollow Hexagonal Handle  
5/16" (8mm) wide**

- SIMZ-391 • Straight
- SIMZ-392 • Medium Curved
- SIMZ-393 • Strong Curved
- SIMZ-394 • Reverse Curved

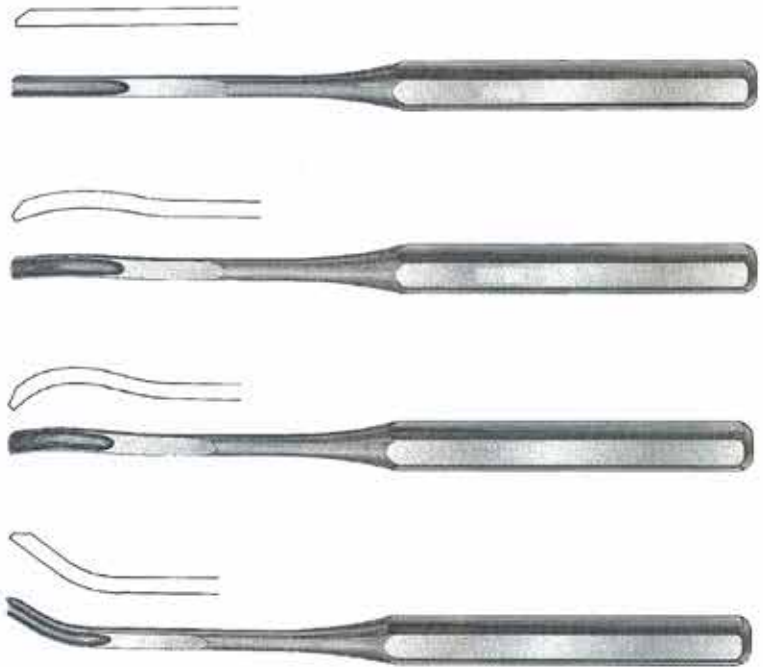

**COBB-Type Spinal Elevators,  
11" (28cm)**

- SIMZ-395 • 3/8" (9mm)
- SIMZ-396 • 1/2" (12mm)
- SIMZ-397 • 3/4" (19mm)
- SIMZ-398 • 1" (25mm)
- SIMZ-399 • 1 1/4" (32mm)



**COBB-Type Spinal Elevators,  
11" (28cm) Solid Hexagonal Handle**

- SIMZ-400 • 3/8" (9mm)
- SIMZ-401 • 1/2" (12mm)
- SIMZ-402 • 3/4" (19mm)



**LAMBOTTE Ostetomes,  
9" (22.9cm), Straight**

- SIMZ-403 • ¼" (6mm)
- SIMZ-404 • ½" (12mm)
- SIMZ-405 • ¾" (19mm)
- SIMZ-406 • 1" (25mm)
- SIMZ-407 • 1 ¼" (32mm)
- SIMZ-408 • 1 ½" (38mm)

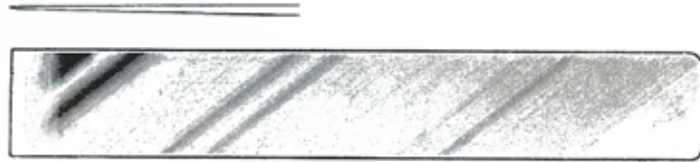

**LAMBOTTE Ostetomes,  
9" (22.9cm), Curved**

- SIMZ-409 • ¼" (6mm)
- SIMZ-410 • ½" (12mm)
- SIMZ-411 • ¾" (19mm)
- SIMZ-412 • 1" (25mm)
- SIMZ-413 • 1 ¼" (32mm)
- SIMZ-414 • 1 ½" (38mm)

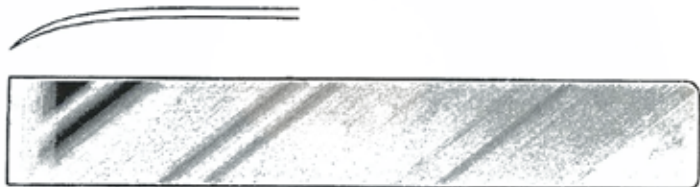

**HOKE Ostetomes,  
5 ½" (14cm), Straight**

- SIMZ-415 • ⅛" (3mm)
- SIMZ-416 • 3/16" (5mm)
- SIMZ-417 • ¼" (6mm)
- SIMZ-418 • 5/16" (8mm)
- SIMZ-419 • ⅜" (9mm)
- SIMZ-420 • ½" (12mm)
- SIMZ-421 • ⅝" (16mm)



**HOKE Ostetomes,  
5 ½" (14cm), Curved**

- SIMZ-422 • ⅛" (3mm)
- SIMZ-423 • 3/16" (5mm)
- SIMZ-424 • ¼" (6mm)
- SIMZ-425 • 5/16" (8mm)
- SIMZ-426 • ⅜" (9mm)
- SIMZ-427 • ½" (12mm)
- SIMZ-428 • ⅝" (16mm)



**STILLE-Type Ostetomes,  
8" (20.3cm)**

- SIMZ-429 • 3/8" (9mm)
- SIMZ-430 • 9/16" (14mm)
- SIMZ-431 • 11/16" (18mm)
- SIMZ-432 • 7/8" (22mm)



**STILLE-Type Gouges,  
8" (20.3cm)**

- SIMZ-433 • 3/8" (9mm)
- SIMZ-434 • 9/16" (14mm)
- SIMZ-435 • 11/16" (18mm)
- SIMZ-436 • 7/8" (22mm)



**STILLE-Type Chisels,  
8" (20.3cm)**

- SIMZ-437 • 3/8" (9mm)
- SIMZ-438 • 9/16" (14mm)
- SIMZ-439 • 11/16" (18mm)
- SIMZ-440 • 7/8" (22mm)



**SIMZ-441 Hand Surgery Ostetomes Set, includes:**

7 ostetomes 5" (12.7cm) long, 2mm, 4mm, 6mm, 8mm, 10mm, 12mm, 14mm wide, nylon capped mallet, in canvas roll

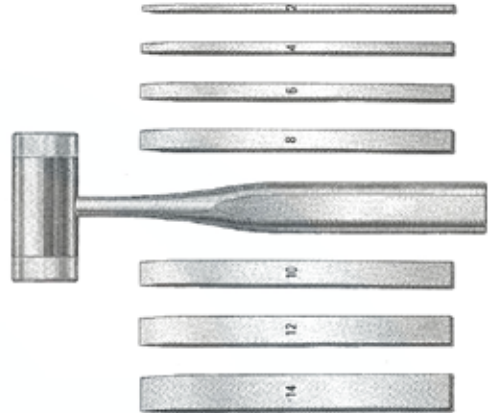

**Hand Surgery Ostetomes 5" (12.7cm), curved**

- SIMZ-442 • 1/16" (2mm)
- SIMZ-443 • 5/32" (4mm)
- SIMZ-444 • 1/4" (6mm)
- SIMZ-445 • 5/16" (8mm)
- SIMZ-446 • 3/8" (10mm)
- SIMZ-447 • 1/2" (12mm)
- SIMZ-448 • 9/16" (16mm)



**Hand Surgery Ostetomes 5" (12.7cm), Straight**

- SIMZ-449 • 1/16" (2mm)
- SIMZ-450 • 5/32" (4mm)
- SIMZ-451 • 1/4" (6mm)
- SIMZ-452 • 5/16" (8mm)
- SIMZ-453 • 3/8" (10mm)
- SIMZ-454 • 1/2" (12mm)
- SIMZ-455 • 9/16" (16mm)



**Mallet, 7 3/8" (18.7cm), anodized aluminum handle includes:**

- SIMZ-456 • 2 replaceable nylon caps, head: weight 4 oz, diameter 1"(2.5cm)
- SIMZ-457 • 1 replaceable nylon cap and 1 stainless facing, head:weight 5 oz diameter 1"(2.5cm)
- SIMZ-458 • NYLON cap For 456-457

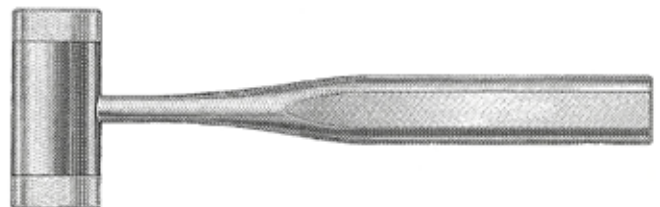

**SIMZ-459 KIRK Mallet,**  
 7 ¼" (19cm) bronze head,  
 head:weight 1 lb 2pz diameter 1 ½"(3.8cm)



**ORTHOPEDIC Mallet**

**SIMZ-460** • 7 3/16"(18.3cm) head: weight 1 lb  
 diameter 1 3/16"(3.0cm)

**SIMZ-461** • 7 9/16" (19.3cm) head:weight 2 lbs diameter  
 1 ½" (3.8cm)

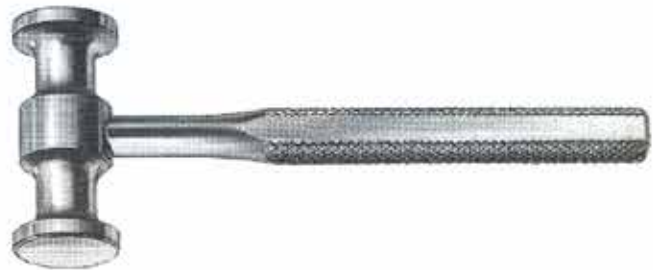

**SIMZ-462 BONE Mallet, 11"(28cm), Lightweight,**  
 head:weight 1 lb  
 diameter 1 3/8" (3.5cm)



**SIMZ-463 BONE Mallet, 11"(28cm), Heavyweight,**  
 head:weight 2 lbs  
 diameter 2" (5.1cm)

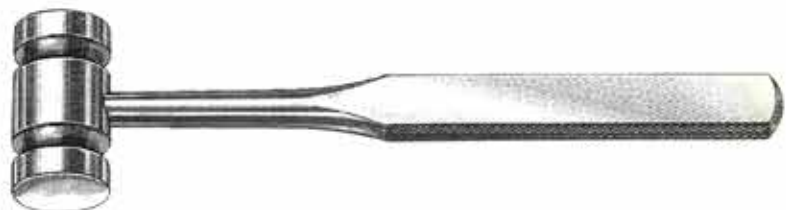





## **SIMZ MEDICAL SUPPLIES LLC**

Milwaukee, Wisconsin, USA

 +1 (414) 514-3542  
+1 (732) 513-4737

 [info@simzmedicalsupplies.com](mailto:info@simzmedicalsupplies.com)

 [www.simzmedicalsupplies.com](http://www.simzmedicalsupplies.com)